

REQUEST FOR PROPOSAL (RFP)

FOR

**LEASE OF UNIT FOR THE PROVISION OF RETAIL STORE
FROM STELCO (HIYAA) COMMERCIAL**

PROPOSAL REFERENCE NUMBER: HDC(161)-MKS/IU/2022/505

ANNOUNCEMENT DATE: 22nd November 2022

PROPOSAL SUBMISSION DEADLINE: 15th December 2022

TABLE OF CONTENTS

SECTION I. INSTRUCTIONS TO PROPONENTS (ITP) 2

SECTION II. RFP DATA SHEET 15

SECTION III. LESSOR'S REQUIREMENTS 17

 1. SCOPE OF WORK 17

 2. BUSINESS MODEL 17

 3. ESTIMATED INVESTMENT COST 17

 4. UNIT DETAILS 17

SECTION IV. QUALIFICATION AND EVALUATION CRITERIA 17

 1. QUALIFICATION CRITERIA 18

 2. EVALUATION CRITERIA 19

SECTION V. BUSINESS PROPOSAL REQUIREMENT 20

 1. BID SECURITY AS IN FORM 01 20

 2. LETTER OF PROPOSAL AS IN FORM 02 20

 3. LEGAL DOCUMENTS: 20

 4. FINANCIAL DOCUMENTS 20

 5. BUSINESS PLAN 22

 6. PROPOSAL CHECKLIST 22

SECTION VI. CONTRACT TERMS 32

SECTION VII. DRAWINGS AND GUIDELINES 37

 1. DRAWINGS 37

 2. UNIT DESIGN GUIDELINES 38



Chi

SECTION I. INSTRUCTIONS TO PROPONENTS (ITP)

A. GENERAL	
1. Scope of Proposal	<p>1.1</p> <p>The Lessor;</p> <p>HOUSING DEVELOPMENT CORPORATION LIMITED an incorporated limited liability company operating under the registration number C793/2008 and having its registered office at HDC Building, 3rd Floor, Hulhumalé Republic of Maldives (hereinafter called and referred to as “the Lessor”,) issues this Request for Proposal (RFP). The name of the Project and Proposal Reference Number of this RFP is provided in the RFP Data Sheet.</p>
	<p>1.2</p> <p>Throughout this RFP Documents:</p> <p>(a) the term “in writing” means communicated in written form and delivered against receipt;</p> <p>(b) except where the context requires otherwise, words indicating the singular also include the plural and words indicating the plural also include the singular; and</p> <p>(c) “day” means calendar day.</p>
2. Corrupt and Fraudulent Practices	<p>2.1</p> <p>It is a requirement of the Lessor that proponents, developers, contractors and their agents (whether declared or not), sub-contractors, sub-consultants, service providers or suppliers, and any personnel thereof, observe the highest standard of ethics during RFP process and execution of Works. In pursuance of this policy, the Lessor:</p> <p>(a) defines, for the purposes of this provision, the terms set forth below as follows:</p> <p>(i) “Corrupt practice” means the offering, giving, receiving, or soliciting of anything of value to influence the action of a public official in the procurement process or in contract execution; and</p> <p>(ii) “Fraudulent practice” means a misrepresentation of facts in order to influence a procurement process or the execution of a contract to the detriment of HDC, and includes collusive practice among Proponent (prior to or after Proposal submission) designed to establish Proposal prices at artificial noncompetitive levels and to deprive HDC of the benefits of free and open competition.</p>



		<p>(b) will reject a proposal for award if it determines that the proponent recommended for award, or any of its personnel, or its agents, or its sub-consultants, sub-contractors, service providers, suppliers and/or their employees, has, directly or indirectly, engaged in corrupt or fraudulent practices in competing for the contract in question.</p> <p>(c) will sanction a firm or individual, at any time including declaring such firm or individual ineligible, either indefinitely or for a stated period of time: to be awarded a contract from Lessor.</p> <p>(d) will terminate the contract after having given fourteen (14) days' notice to the Proponent.</p>
<p>3. Eligible Proponents</p>	<p>3.1</p>	<p>A Proponent must be a registered business (sole trader, partnership or limited liability company) – subject to ITP 3.2 and ITP 3.3.</p>
	<p>3.2</p>	<p>Unless otherwise specified in the RFP data sheet, in case a Joint Venture (JV) is proposed by Proponent(s) the minimum percentage of equity share proportion of local partner(s) in a JV shall not apply.</p>
	<p>3.3</p>	<p>A Proponent shall not have a conflict of interest. Any Proponent found to have a conflict of interest shall be disqualified. A Proponent may be considered to have a conflict of interest for the purpose of this RFP process, if the Proponent:</p> <ul style="list-style-type: none"> (a) directly or indirectly controls, is controlled by or is under common control with another Proponent; or (b) receives or has received any direct or indirect subsidy from another Proponent; or (c) has a relationship with another Proponent, directly or through common third parties, that puts it in a position to influence the proposal of another Proponent, or influence the decisions of the Lessor regarding this RFP process; or (d) submits more than one proposal for a unit in this RFP process by business entity. Participation by a Proponent in more than one Proposal will result in the disqualification of all Proposals in which such Proponent is involved.



Handwritten signature or initials in blue ink.

	3.4	A Proponent shall not be under suspension from proposal submission by the Lessor.
	3.5	A Proponent shall provide such evidence of eligibility satisfactory to the Lessor, as the Lessor shall reasonably request.
	3.6	Employees of HDC shall not be eligible to submit any proposals under this RFP
	3.7	<p>If a proponent has a relation with an employee within HDC, that is in a position to influence the proposal of the proponent, or influence the decisions of the Lessor regarding the RFP process, the proponent shall declare the relationship as per the Declaration Form in Section V.</p> <p>In case where the Proponent has not declared such information and any such information is revealed/identified at any stage of this RFP Process, Lessor has the right to disqualify the submitted proposal.</p>

B. CONTENTS OF RFP DOCUMENTS

4. Sections of RFP Documents	4.1	<p>The RFP Documents include all the Sections specified below, and should be read in conjunction with any Addenda issued in accordance with ITP 6.</p> <ul style="list-style-type: none"> • Section I. Instructions to Proponents (ITP) • Section II. RFP Data Sheet • Section III. Lessor's Requirements • Section IV. Qualification and Evaluation Criteria • Section V. Business Proposal Requirement • Section VI. Contract Terms • Section VII. Drawings and Guidelines
	4.2	<p>Unless obtained directly from the Lessor, the Lessor is not responsible for the completeness of the RFP Documents, responses to requests for clarification, or Addenda to the RFP Documents in accordance with ITP 6. In case of any contradiction, documents obtained directly by the Lessor shall prevail.</p>
	4.3	<p>The Proponent is expected to examine all instructions, forms, terms, and specifications in the RFP Documents. Failure to furnish all information and documentation required in RFP</p>



[Handwritten signature]

		Documents as per ITP 4.1 may result in rejection of the proposal.
5. Clarification of RFP Documents, Pre-Proposal Meeting	5.1	A Proponent requiring any clarification of the RFP Documents shall contact the Lessor in writing at the Lessor's address specified in the RFP Data Sheet or raise its enquiries during the Pre-Proposal Meeting, if provided for in accordance with ITP 5.2. The Lessor will respond in writing to any request for clarification, provided that such request is received no later than the enquiry deadline specified in the RFP Data Sheet . The Lessor shall promptly publish its response at the web page specified in the RFP Data Sheet . Should the clarification result in changes to the essential elements of the RFP Documents, the Lessor shall amend the RFP Documents following the procedure under ITP 6 and ITP 16.2.
	5.2	If so, specified in the RFP Data Sheet , the Proponent's designated representative is invited to attend a pre-proposal meeting. The purpose of the meeting will be to provide information about the project, proposal procedures, clarify issues and to answer questions on any matter that may be raised at that stage.
	5.3	Minutes of the pre-proposal meeting, if applicable, including the text of the questions asked by Proponents, without identifying the source, and the responses given, together with any responses prepared after the meeting, will be published promptly in webpage in accordance to ITP 5.1. Any modification to the RFP Documents that may become necessary as a result of the pre-proposal meeting shall be made by the Lessor exclusively through the issue of an Addendum pursuant to ITP 6 and not through the minutes of the pre-proposal meeting. Nonattendance at the pre-proposal meeting will not be a cause for disqualification of a Bidder.
6. Amendment of RFP Documents	6.1	At any time prior to the deadline for submission of proposal, the Lessor may amend the RFP Documents by issuing addenda.
	6.2	Any addendum issued shall be part of the RFP Documents and shall promptly publish the addendum on the Lessor's web page in accordance with ITP 5.1.

	6.3	To give Proponents reasonable time in which to take an addendum into account in preparing their proposal, the Lessor may extend the deadline for the submission of proposal, pursuant to ITP 16.2.
C. PREPARATIONS OF PROPOSALS		
7. Cost of Proposal	7.1	The Proponent shall bear all costs associated with the preparation and submission of its proposal, and the Lessor shall not be responsible or liable for those costs, regardless of the conduct or outcome of the RFP Process.
8. Language of Proposal	8.1	The RFP, as well as all correspondence and documents relating to the RFP exchanged by the Proponent and the Lessor, shall be written in the ENGLISH or DHIVEHI language.
9. Documents Comprising the Proposal	9.1	The Proposal shall comprise the following: <ul style="list-style-type: none"> (a) Bid Security in accordance with ITP 13; (b) Written confirmation authorizing the signatory of the Proposal to commit the Proponent, in accordance with ITP 14.2 and ITP 14.3; (c) Business Proposal Requirement stipulated in Section V; (d) In the case of a Proposal submitted by a Joint Venture (JV), the JV agreement or letter of intent to enter into JV including but not limited to scope of works to be executed by respective partners and equity share percentage of the respective partners; (e) Any other document required in RFP data sheet.
10. Letter of Proposal	10.1	The Letter of Proposal shall be prepared using the Form 02 in Section V. The form must be completed without any alterations to the text, and no substitutes shall be accepted. All blank spaces shall be filled in with the information requested.
	10.2	The Proponent shall quote prices conforming to the requirements specified in Section III.
11. Currencies of Proposal	11.1	The currency(ies) of the proposal are to be quoted in Maldivian Rufiyaa (MVR).
12. Period of Validity of Proposals	12.1	Proposal shall remain valid for the period specified in the RFP Data Sheet . A proposal valid for a shorter period shall be rejected by the Lessor as non-responsive.

13. Bid Security	13.1	The Proponent shall furnish as part of its proposal, a bid security in original form and in the amount and currency specified in the RFP Data Sheet.
	13.2	The Bid Security shall be valid for the period specified in the RFP Data Sheet.
	13.3	The Bid Security shall be a demand guarantee in forms of an unconditional guarantee issued by a locally registered Bank or financial institution (such as an insurance, bonding or surety company). The bid security shall be submitted as per Form 01 in Section V.
	13.4	The Bid Security of a JV shall be in the name of the JV that submits the bid. If the JV has not been legally constituted into a legally enforceable JV at the time of bidding, the bid security shall be in the names of all future members as named in the letter of intent referred to in ITP 3.1 and ITP 9.1
	13.5	Any proposal not accompanied by a substantially responsive bid security shall be rejected by the Lessor as non-responsive.
	13.6	The Bid Security of the successful Proponent shall be returned as promptly as possible once the successful Proponent has signed the Contract.
	13.7	The Bid Security of unsuccessful Proponents shall be returned as promptly as possible upon the successful Proponent's signing the Contract.
	13.8	The Bid Security may be forfeited or the Bid Securing Declaration Executed: <ul style="list-style-type: none"> (a) If the proponent withdraws its Proposal during the period of Proposal validity specified by the Proponent in the Letter of Proposal; or (b) If the successful proponent (i) fails or refuses to pay lease deposit, or (ii) fails to execute the terms and conditions of the conditional award of the Lessor.
14. Format and Signing of Proposal	14.1	The Proponent shall submit one original of the documents comprising the proposal as described in ITP 9.1.
	14.2	The original and all copies of the proposal shall be typed or written in indelible ink and shall be signed by a person duly authorized to sign on behalf of the Proponent. This

		authorization shall consist of a written confirmation of a Power of Attorney to sign on behalf of the Proponent. The name and position held by each person signing the authorization must be typed or printed below the signature. All pages of the proposal where entries or amendments have been made shall be signed or initialed by the person signing the proposal.
	14.3	In case the Proponent is a JV, the Proposal shall be signed by an authorized representative of the JV on behalf of the JV, and so as to be legally binding on all the members as evidenced by a power of attorney signed by their legally authorized representatives.
	14.4	Any inter-lineation, erasures, or overwriting shall be valid only if they are signed or initialed by the person signing the proposal.

D. SUBMISSION AND OPENING OF PROPOSALS

15. Sealing and Marking of Proposals	15.1	<p>Proponents shall submit their proposal by mail or by hand. If so, specified in the RFP Data Sheet, Proponents shall have the option of submitting their Proposal electronically. Procedures for submission, sealing and marking are as follows:</p> <ul style="list-style-type: none"> (a) Proponents submitting Proposal by mail or by hand shall enclose the original of the Bid in one sealed single envelope, duly marking the envelope as "ORIGINAL BID". (b) Proponent submitting Proposal electronically shall follow the electronic bid submission procedures specified in the RFP data sheet.
	15.2	<p>The sealed envelope shall:</p> <ul style="list-style-type: none"> (a) bear the name and address of the Proponent; (b) bear the name of the Project and shall be addressed to the Lessor; (c) bear the specific proposal reference number of this RFP process indicated in RFP Data Sheet; (d) bear the name, address and contact number and contact person of the Proponent. (e) bear a warning not to open before the time and date for proposal opening in accordance with ITP 16.1.



C-793/2008

 HOUSING DEVELOPMENT CORPORATION LTD.

		(f) include Form 07 - Proposal Checklist
	15.3	If the envelope is not sealed and marked as required, the Lessor will assume no responsibility for the misplacement or premature opening of the proposal.
16. Deadline for Submission of Proposal	16.1	Proponents must submit the required documents to the online portal no later than the date and time specified in the RFP Data Sheet.
	16.2	Proposals must be received by the Lessor at the address and no later than the Proposal Submission date and time specified in the RFP Data Sheet.
17. Late Proposal	17.1	The Lessor shall not consider any proposals that arrives after the deadline for submission of proposal specified in ITP 16. Any proposal received by the Lessor after the deadline for submission of proposal shall be declared late, rejected, and returned unopened to the Proponent.
18. Proposal Opening	18.1	The Lessor shall open Proposals at the address on the date and time specified in the RFP Data Sheet in the presence of Proponent's designated representatives and anyone who choose to attend. Any specific electronic bid opening procedures required if electronic bidding is permitted in accordance with ITP 15.1, shall be specified in the RFP Data Sheet.
	18.2	The Lessor shall open the proposals one at a time and read out and record the following <ul style="list-style-type: none"> (a) the name of the Proponent; (b) the presence of original Bid Security; (c) any other details as the Lessor may consider appropriate.
	18.3	Only proposals read out and recorded at proposal opening shall be considered for evaluation. No Proposal shall be rejected at the opening except for late proposal in accordance with ITP 17.1 and proposals that are not in accordance with Form 07 - Proposal Checklist.
	18.4	The Lessor shall prepare a record of the proposal opening that shall include, as a minimum: the name of the Proponent; the Price; and the presence or absence of a bid security, if one was required. The Proponents' representatives who are present shall be requested to sign the record. The omission

		of a Proponent's signature on the record shall not invalidate the contents and effect of the record. A copy of the record shall be distributed to all Proponents who submitted proposal on time.
E. EVALUATION AND COMPARISON OF PROPOSALS		
19. Confidentiality	19.1	Information relating to the evaluation of proposals, comparison of proposals and recommendation of contract award shall not be disclosed to Proponents or any other persons not officially concerned with the RFP process until information on Contract award is communicated to all Proponents in accordance with ITP 28.
	19.2	Any attempt by a Proponent to influence the Lessor in the evaluation of the proposals or Contract award decisions may result in the rejection of its proposal.
	19.3	Notwithstanding ITP 20.2, from the time of proposal opening to the time of Contract award, if a Proponent wishes to contact the Lessor on any matter related to the RFP process, it shall do so in writing.
20. Clarification of Proposals	20.1	To assist in the examination, evaluation, and comparison of the proposals, and qualification of the Proponents, the Lessor may, at its discretion, ask any Proponent for a clarification of its proposal, giving a reasonable time for a response. Any clarification submitted by a Proponent that is not in response to a request by the Lessor shall not be considered. The Lessor's request for clarification and the response shall be in writing. No change, including any voluntary increase or decrease, in the prices or substance of the proposal shall be sought, offered, or permitted, except to confirm the correction of arithmetic errors discovered by the Lessor in the evaluation of the proposals, in accordance with ITP 23.
	20.2	If a Proponent does not provide clarifications of its proposal by the date and time set in the Lessor's request for clarification, its proposal may be rejected.
21. Deviations, Reservations, and Omissions	21.1	During the evaluation of proposal, the following definitions apply: (a) "Deviation" is a departure from the requirements specified in the RFP Documents;

		<p>(b) "Reservation" is the setting of limiting conditions or withholding from complete acceptance of the requirements specified in the RFP Documents; and</p> <p>(c) "Omission" is the failure to submit part or all of the information or documentation required in the RFP Documents.</p>
22. Determination of Responsiveness	22.1	The Lessor's determination of a proposal's responsiveness is to be based on the contents of the proposal itself, as defined in ITP 9.1.
	22.2	A substantially responsive proposal is one that meets the requirements of the RFP Documents without material deviation, reservation, or omission.
	22.3	<p>A substantially responsive proposal is one that meets the requirements of the RFP Documents without material deviation, reservation, or omission. A material deviation, reservation, or omission is one that,</p> <p>(a) if accepted, would</p> <p>(i) affect in any substantial way the scope, quality, or performance of the Works specified in the Contract; or</p> <p>(ii) limit in any substantial way, inconsistent with the RFP Documents, the Lessor's rights or the Proponent's obligations under the proposed Contract; or</p> <p>(b) if rectified, would unfairly affect the competitive position of other Proponents presenting substantially responsive proposal.</p>
	22.4	If a proposal is not substantially responsive to the requirements of the RFP Documents, it shall be rejected by the Lessor and may not subsequently be made responsive by correction of the material deviation, reservation, or omission.
23. Correction of Arithmetical Errors	23.1	<p>Provided that the proposal is substantially responsive, the Lessor shall correct arithmetical errors on the following basis:</p> <p>(a) if there is a discrepancy between the unit price and the total price that is obtained by multiplying the unit price and quantity, the unit price shall prevail and the total price shall be corrected, unless in the opinion of the Lessor there is an obvious misplacement of the decimal point in the unit price,</p>



[Handwritten signature]

		<p>in which case the total price as quoted shall govern and the unit price shall be corrected;</p> <p>(b) if there is an error in a total corresponding to the addition or subtraction of subtotals, the subtotals shall prevail and the total shall be corrected; and</p> <p>(c) if there is a discrepancy between words and figures, the amount in words shall prevail, unless the amount expressed in words is related to an arithmetic error, in which case the amount in figures shall prevail subject to (a) and (b) above.</p>
	23.2	Proponents shall be requested to accept correction of arithmetical errors. Failure to accept the correction in accordance with ITP 23.1, shall result in the rejection of the Proposal.
24. Evaluation of Proposal	24.1	The Lessor shall use the criteria and methodologies listed in Section IV. Qualification and Evaluation Criteria.
	24.2	In the event, the difference in total evaluation scores of two or more Proponents is less than 3% the Proponent proposing the highest revenue (Net Present Value) will be ranked the highest among the Proponents with less than 3% and the rest of the Proponents within this range will be ranked accordingly.
25. Lessor's Right to Obtain Additional Documents	25.1	During Evaluation of the Section IV. Qualification and Evaluation Criteria, if additional documents are required for the qualification of the proposal submitted by the Proponent, the Lessor shall have the rights to call for additional documents within a set period of time. As such any documents requested within the evaluation period will not affect the evaluation scoring of a Proposal and shall only be for the purpose of qualifying a submitted proposal.
	25.2	<p>a) In the event where more than 1 (one) Proposal is received for the RFP, Proponents with higher NPVs are required to submit additional documents in order to qualify, the Lessor shall have the rights to call for additional documents within a set period of time.</p> <p>b) In the event where only 1 (one) Proposal is received for the RFP, the Lessor may call for additional documents within a set period of time in order to save the time of the allocation.</p>

	25.3	The Lessor shall communicate via email with the Authorized Representative specified in the Proposal by the Proponent if additional documents are required as per ITP 25.1 and ITP 25.2
	25.4	Proponents who are required to submit additional documents shall submit the documents within the time specified by the Lessor subject to ITP 25.3. Evaluation will be carried out with the initial documents submitted with the Proposal by the Proponents in the event where they fail to submit the required documents.
26. Lessor's Right to Accept Any Proposal, and to Reject Any or All Proposal	26.1	The Lessor reserves the right to accept or reject any proposal, and to annul the RFP process and reject all proposals at any time prior to contract award, without thereby incurring any liability to Proponents. In case of annulment, all proposals submitted and specifically, bid securities, shall be promptly returned to the Proponents.
F. AWARD OF CONTRACT		
27. Award Criteria	27.1	Subject to ITP 26.1, the Lessor shall conditionally award the Contract to the Proponent(s) whose proposals has been determined to be substantially responsive to the RFP Documents and scored the highest marks as specified in ITP 24, provided further that the Proponent is determined to be qualified to perform the Contract satisfactorily.
	27.2	In case of multiple units are specified in Section III, the Lessor shall conditionally award the Contract to the Proponents as per evaluation ranking subject to ITP 27.1
28. Unit Selection	28.1	Unit Selection for the Successful Proponents shall be carried out as per procedures specified in the RFP data sheet.
29. Notification of Conditional Award	29.1	Prior to the expiration of the period of proposal validity, the Lessor shall notify the successful Proponent, in writing, that its proposal has been accepted
	29.2	Until a formal contract is prepared and executed, the successful Proponents' proposal and the notification of conditional award shall constitute a binding Contract.

	29.3	Failure of the successful Proponent to fulfill the obligations mentioned in the Conditional Award Letter, or sign the Contract in accordance with ITP 30 shall constitute sufficient grounds for the annulment of the conditional award and forfeiture of the bid security. In that event the Lessor may award the Contract to the next highest evaluated Proponent whose offer is substantially responsive.
30. Signing of Contract	30.1	Promptly upon notification of the conditional award, the Lessor shall send the successful Proponent the Contract
	30.2	Within 7 (seven) days of the success fulfilment of the obligation stipulated in Conditional Award Letter, successful Proponent shall sign the Contract with Lessor.

SECTION II. RFP DATA SHEET

A. GENERAL	
ITP 1.1	Name of the Project: Lease of Unit for The Provision of Retail Store from STELCO (Hiyaa) Commercial
ITP 1.1	The Reference Number of Proposal Process is: HDC(161)-MKS/IU/2022/505
ITP 3.2	Joint Venture share proportion restriction shall not apply.
B. CONTENTS OF RFP DOCUMENTS	
ITP 5.1	For clarification purposes only, the Lessor's address is: Marketing and Sales Housing Development Corporation Ltd. Ground Floor, HDC Building Hulhumalé, Maldives Tel: (+960)335 3535, (+960)335 5314, (+960)335 5376 E-mail: sales@hdc.com.mv
ITP 5.1	Webpage: Corporate website - hdc.com.mv MyHulhumalé Properties website - properties.hdc.com.mv Bids & Proposal Submission Portal - bids.hdc.com.mv
ITP 5.1	The deadline for request for clarification is on or before 04th December 2022 at 14:00hrs
ITP 5.2	The pre-proposal meeting shall take place at the following date, time and place; Date: 30th November 2022 Time: 13:00hrs Place: Online Meeting held via Zoom Interested parties can join pre-proposal meeting via zoom link shared on Invitation for Proposals. In order to minimize technical issues please join the meeting 10 minutes prior to the time.
C. PREPARATIONS OF PROPOSALS	
ITP 12.1	Proposal Validity Period: 150 (One Hundred and Fifty) days

ITP 13.1	<p>The Amount and Currency of Bid Security shall be MVR 5,000.00 (Maldivian Rufiyaa Five Thousand) or equivalent in United States Dollar (USD).</p> <p>The source of exchange rate shall be Maldives Monetary Authority (MMA) and the date for the exchange rate shall be 14 (fourteen) days before Proposal Submission deadline.</p>
ITP 13.2	<p>Bid Security Validity Period: 180 (One Hundred and Eighty) days from the deadline for submission of Proposals.</p>
D. SUBMISSION AND OPENING OF PROPOSALS	
ITP 15.1	<p>Proponents do not have the option of submitting their proposal electronically</p>
ITP 16.2	<p>For proposal submission purpose only, the Lessor Address is:</p> <p>Exhibition Center (Ground Floor) HDC Building Huvandhumaa Hingun Housing Development Corporation Ltd.</p> <p>Date: 15th December 2022 Time: 13:00hrs to 14:00hrs</p>
ITP 18.1	<p>For proposal opening shall take place at:</p> <p>Exhibition Center (Ground Floor) HDC Building Huvandhumaa Hingun Housing Development Corporation Ltd.</p> <p>Date: 15th December 2022 Time: 14:00hrs</p> <p><i>Proposal Opening will be held physically in front of the proponents participating at Proposal Opening.</i></p>
E. AWARD OF CONTRACT	
ITP 28.1	<p>Unit Selection Shall not apply.</p>

SECTION III. LESSOR'S REQUIREMENTS

1. SCOPE OF WORK

Housing Development Corporation (Lessor) is seeking interested parties for the Lease of Unit for The Provision of Retail Store from STELCO (Hiyaa) Commercial. The selected parties (Lessee) will be responsible for the design and operation of the unit for the duration of lease term as per the guidelines set forth by HDC. The operation of the unit includes but is not limited to, management, administration, supervision and maintenance of the unit.

2. BUSINESS MODEL

- 2.1 The Business Model is Lease Model, whereby the Lessee agrees to pay the proposed Lease to the Lessor.
- 2.2 Lease rate for the Year 1 will be fixed at MVR 40.00 (Maldivian Rufiyaa Forty) per square feet.
- 2.3 The Lessee shall propose Lease rate for the Year 2, Year 3, Year 4 and Year 5. The minimum acceptable Lease rate per square feet per month is MVR 40.00 (Maldivian Rufiyaa Forty).
- 2.4 The lease rate proposed for each following year shall be equal or higher than the previous year's lease rate. Proposed lease rate which is less than the minimum acceptable lease rate shall be disqualified.

3. ESTIMATED INVESTMENT COST

- 3.1 Estimated Investment Cost for the units are **MVR 178,509.00** (Maldivian Rufiyaa One Hundred Seventy-Eight Thousand Five Hundred and Nine) This amount is derived based on the unit area, unit usage and the scope of work essential for the operation of the unit.
- 3.2 The calculation basis for Estimated Investment Cost is calculated at the rate of MVR **300.00** (Maldivian Rufiyaa Three Hundred) per square feet of the unit area.

4. UNIT DETAILS

Unit Number	Usage	Unit Area (sqft)
20458-G-02	Retail Store	595.03
20458-G-03	Retail Store	595.03

Drawings and Guideline related to the unit will be included in the Section VII. Drawings and Guidelines.



SECTION IV. QUALIFICATION AND EVALUATION CRITERIA

This Section contains all the criteria that the Lessor shall use to qualify Proponents and evaluate the proposals. In accordance with ITP 24, no other factors, methods or criteria shall be used. The Proponent shall provide all the information / documents requested in the Section V, Business Proposal Requirements and proposal shall fulfill requirements in accordance with ITP 9.1.

1. QUALIFICATION CRITERIA

Proponents that meet the requirement set in Qualification Criteria of Section IV will be evaluated according to evaluation criteria.

1.1. Financial Resources

- (a) Proponent shall provide proof of funds to finance the full Estimated Investment Cost by the Lessor as per Section III. Lessor's Requirement, Clause 3.
- (b) Financial resources will be evaluated based on the method of financing proposed, and the documents submitted by the Proponents as per Section V. Business Proposal Requirement, Clause 4.
- (c) Proponents who do not show proof of funds to finance the proposed investment cost shall be disqualified.

1.2. Outstanding Payment

- (a) Proponent shall not have any due payment to Lessor prior to 30 (Thirty) calendar days to Proposal Submission.
- (b) Proponents who have payment due prior to 30 (Thirty) calendar days of the submission of RFP shall be disqualified.

1.3. History of Non-Performing Contracts and Compliance with Court Verdicts

- (a) Proponents whose agreement has been terminated due to Proponent's non-performance within last 5 (Five) years will be disqualified.
- (b) Proponents who do not have complied with any court verdicts in relation to an agreement made with HDC, within the last 5 (Five) years shall be disqualified.

2. EVALUATION CRITERIA

Proposals that meet the requirements set in Qualification Criteria of Section III will be evaluated based on the following evaluation criteria and points will allocated as below:

Criteria	Allocated %
a) Lease Rate	80%
b) Business Plan	20%
Total	100%

2.1. Lease Rate – 80%

- 2.1.1. The Lease Rate will be evaluated using the Net Present Value (NPV) of the proposed Lease Rate by the Proponent for the first five years after grace period.
- 2.1.2. Proponents with highest NPV will be given the maximum score for the Lease rate, whereby points shall be given as prorated for other Proponents.
- 2.1.3. NPV will be calculated as per the following formula with the discount rate of 10%

$$\sum_{t=0}^n \frac{I}{(1+r)^t}$$

n= number of years

I = rent proposed per month for each year starting from first year

r= discount rate (10%)

- 2.1.4. Lease rate shall be proposed as per Section III Lessor's Requirement and proposals that are not in accordance Section III shall result in disqualification of proposal.

2.2. Business Plan – 20%

The business plan will be evaluated based on the following criterion:

- 2.2.1. Marketing Analysis and Strategy - 40 points
- 2.2.2. Financial Plan - 30 points
- 2.2.3. Management and Operational Plan - 30 points

SECTION V. BUSINESS PROPOSAL REQUIREMENT

To establish its qualifications to perform the contract in accordance with *Section IV Qualification and Evaluation Criteria* and to determine the proposal as substantially responsive proposal, Proponent shall provide the information requested in the corresponding documents included hereunder. Proponents are advised to submit the proposal in the following order and include page of content and separators for each section.

1. BID SECURITY AS IN FORM 01

2. LETTER OF PROPOSAL AS IN FORM 02

3. LEGAL DOCUMENTS:

- 3.1 Copy of Business Registration Certificate
- 3.2 For Partnership; Partnership Deed / Agreement
- 3.3 For Company; Memorandum and Articles of Association of the Company
- 3.4 For Company; Board Resolution of the Company confirming Board of Director's approval for proposed work
- 3.5 Information of the Authorized Representative as in Form 03
- 3.6 Declaration of Immediate Family Members as in Form 07
- 3.7 Power of Attorney to sign on behalf of the Proponent in accordance with ITP 14.2
- 3.8 In the case of a Proposal submitted by a Joint Venture (JV), the JV agreement or letter of intent to enter into JV including but not limited to scope of works to be executed by respective partners and equity share percentage of the respective partners
- 3.9 Document indicating the ownership and shareholding structure of the Proponent.

4. FINANCIAL DOCUMENTS

4.1. HDC statement of the Due Clearance

4.1.1. Due clearance statement from HDC will be given upon request from the proponent via Due Clearance Form.

- Due Clearance Form will be available to download via the following link:
<https://hdc.com.mv/downloads/>

4.2. Financing Method(s) as in Form 04

4.2.1 Proposed method(s) of financing the Estimated Investment Cost and the percentage ratio of method (s). Proposed method(s) of financing for investment can be equity financing, equity injection, bank finance, external finance such as financier company, lines of credit, time deposit, tradable bonds or combination of various financing methods.

4.3 Based on the proposed method of Financing, the following documents are required:

4.3.1 Equity Financing by a Sole Proprietorship:

- (a) Monthly Average Balance Confirmation of the most recent 12 (twelve) months or End Balance Confirmation of the business entity shall be submitted. The submitted statement shall be original, authorized and sealed (Stamped) by the bank / financial institution.

4.3.2 Equity Financing by a Company:

- (a) Monthly Average Balance Confirmation of the most recent 12 (twelve) months or End Balance Confirmation of the business entity shall be submitted. The submitted statement shall be original, authorized and sealed by the bank / financial institution.
- (b) For Company, audited financial statements of most recent year (2021) authorized by a certified audit firm / individual and management account of the year 2022. The audited financial statements must include auditors report and shall be signed and stamped by the respective parties. If the company is not audited as per MIRA requirements, documents as per Clause 4.3.1 shall be submitted.

4.3.3 Bank Financing:

- (a) Bank comfort letter/bank guarantee or any other relevant documents from bank or financial institutions shall be submitted. The submitted documents shall include the Proponent(s) name and name of proposed work/ project (RFP Name).

4.3.4 Equity Injection:

- (a) Letter of commitment from shareholder including the Proponent(s) name and name of the proposed work/ project (RFP Name).
- (b) Shareholder's monthly Average Balance Confirmation or End Balance Confirmation (as per Section V Clause 4.3.1 (a)) or shareholder's audited financial statements (as per Section V Clause 4.3.2 (b)) or relevant documents for bank financing by shareholder (as per Section V Clause 4.3.3) or relevant documents for external financing by shareholder (as per Section V Clause 4.3.5) shall be submitted.

4.3.5 External Financing:

- (a) Letter of commitment from financier including the Proponent(s) name and name of the proposed work/ project (RFP Name).
- (b) Financier's Monthly Average Balance Confirmation or End Balance confirmation (as per Section V Clause 4.3.1 (a)) or financier's audited financial statements (as per Section V Clause 4.3.2 (b)) or relevant documents for bank financing by financier (as per Section V Clause 4.3.3) shall be submitted.

5. BUSINESS PLAN

The proponent shall submit a business plan including:

- 5.1. Marketing Analysis and Strategy
 - 5.1.1. Marketing analysis including target market and competitors.
 - 5.1.2. Marketing strategy including product strategy, price strategy and promotional strategy.
 - 5.1.3. Description of Products or Services offered.
- 5.2. Financial Plan
 - 5.2.1. Financial forecast including capital budget, profit and loss statement, cash flow statement and investment indicators.
- 5.3. Management and Operational Plan
 - 5.3.1. Management and operational details
 - 5.3.2. Resource requirement and Human resources plan.

6. PROPOSAL CHECKLIST

- 6.1 Proposal Checklist as in Form 05 should be attached outside the sealed envelope.

FORM 01: BID SECURITY FORM

The Issuing Bank shall fill in this Bank Security Form in accordance with the instructions indicated.

_____ {Bank's Name, and Address of Issuing Branch or Office}

Beneficiary.: Housing Development Corporation Ltd., 3rd Floor, HDC Building, Hulhumalé, Republic of Maldives,

Date.: _____

Bid Security No.: _____

We have been informed that _____ {name of the proponent} (hereinafter called "the Proponent") has submitted their proposal dated _____ {date of proposal submission} for the execution of _____ {name of project} (hereinafter called "the RFP") under Invitation for Proposal No. _____ {invitation for proposal}.

Furthermore, we understand that, according to your conditions, Proposals must be supported by a Bid Security.

At the request of the Proponent, we _____ {name of Bank} hereby irrevocably undertake to pay you any sum or sums not exceeding in total an amount of _____ [amount in figures] (_____) [amount in words] upon receipt by us of your first demand in writing accompanied by a written statement stating that the Proponent is in breach of its obligation(s) under the RFP conditions, because the Proponent:

- (a) has withdrawn its Proposal during the period of Proposal validity specified by the Proponent in the Letter of Proposal; or
- (b) having been notified of the acceptance of its Proposals by the Employer during the period of Proposal validity, (i) fails or refuses to pay lease deposit, or (ii) fails to execute the term and conditions of the conditional award of the Employer.

This guarantee will expire: (a) if the Proponent is the successful Proponent, upon our receipt of copies of the agreement signed by the Proponent and the lease deposit furnished to you upon the instruction; and (b) if the Proponent is not the successful Proponent, upon the earlier of (i) our receipt of a copy of your notification to the Proponent of the name of the successful Proponent; or (ii) **180 (One Hundred and Eighty)** calendar days from {date of submission} of the Proposal for the RFP.

Consequently, any demand for payment under this guarantee must be received by us at the office on or before that date.

This guarantee is subject to the Uniform Rules for Demand Guarantees, ICC Publication No. 758
[seal and signature of the bank / financial institution]



FORM 02: LETTER OF PROPOSAL

Date:
Name of the Project:
Proposal Reference No:

To: Housing Development Corporation Ltd.
Ground Floor, HDC Building
Hulhumalé, Maldives

We, the undersigned, declare that:

- (a) We have examined and have no reservations to the Request for Proposal (RFP) documents including all addenda issued in accordance with Instruction to Proponents (ITP) 6.
- (b) We meet the eligibility requirements and have no conflict of interest in accordance with ITP 3;
- (c) We have not been suspended nor declared ineligible by the Lessor in accordance with ITP 3.3.
- (d) We have no outstanding payment due to the Lessor in accordance with Section III.
- (e) We have no non-performance of a contract and non-compliance with court verdicts in accordance with Section III.
- (f) We, (insert *business name and business registry number*), offer to (insert name of the Project).
- (g) We undertake, to pay the proposed Lease rate for 05 (Five) years, where proposal is accepted. The lease rate is:
1st Year (per square feet per month): MVR 40.00 (Maldivian Rufiyaa Forty)
2nd Year (per square feet per month): MVR L (*amount in numbers*)
(RufiyaaLaari.....) (*amount in words*)
3rd Year (per square feet per month): MVR L (*amount in numbers*)
(RufiyaaLaari.....) (*amount in words*)
4th Year (per square feet per month): MVR L (*amount in numbers*)
(RufiyaaLaari.....) (*amount in words*)
5th Year (per square feet per month): MVR L (*amount in numbers*)
(RufiyaaLaari.....) (*amount in words*)
- (h) Where the proposal is successful, we undertake, to adhere the Drawings and Guidelines stated in Section VII, during the design and construction of the development / Unit.



- (i) Our proposal shall be valid for a period of One Hundred and Fifty (150) days from the date of proposal submission deadline in accordance with RFP document and it shall remain binding upon us and may be accepted at any time before the expiration of that period.
- (j) We understand that this proposal, together with your written acceptance thereof included in your notification of award, shall constitute a binding contract between us, until a formal contract is prepared and executed; and
- (k) We understand that Lessor is not bound to accept the highest evaluated proposal or any proposal that the lessor may receive.

Proponent:

Name:

(Seal)

Address:

Duly authorized to sign the proposal for and on behalf of the Company:

Name:

Title:

Signature:

Date:



FORM 03: INFORMATION OF THE AUTHORIZED REPRESENTATIVE

Date:
Proposal Reference No:.....

To: Housing Development Corporation Ltd.
Ground Floor, HDC Building
Hulhumalé, Maldives

This is to authorize (*Name, ID number*) as a representative of (*Name of the Proponent*) to carry out the Project related to RFP (ref no) and to liaise with Lessor on behalf of the (*Name of the Proponent*)

Proponent:

Name:

Address:

.....

Signature and Stamp

Authorized Representative (preferably fulltime personal):

Name:

Designation:

ID Number:

Contact Number:

Email Address:

.....

Signature



FORM 04: FINANCING METHOD(S)

Date:

Name of the Project:

Proposal Reference No:.....

To: Housing Development Corporation Ltd.
Ground Floor, HDC Building
Hulhumalé, Maldives

Where the proposal is successful, we undertake, to finance the project/work under:

..... (Method of financing) (percentage ratio)

..... (Method of financing) (percentage ratio)

..... (Method of financing) (percentage ratio)

..... (Method of financing) (percentage ratio)

We hereby confirm and agree to finance the project/work will be financed by the above-mentioned method(s). We have submitted relevant documents to provide proof of funding, to the proposed method(s) of financing the project/work. We understated that the proposal will be disqualified if the documents do not show proof of funds to finance the Estimated Project Cost or if the documents are not in accordance with Section V. Business Proposal Requirement Clause 4. Financial Documents.

Proponent:

Name:

Address:

.....

Signature and Stamp



FORM 05 - PROPOSAL CHECKLIST

Proponents are required to submit Form 05 – Proposal Checklist outside the sealed envelope of the Proposal

Proponent	For HDC use	
<input type="checkbox"/>	<input type="checkbox"/>	1. Bid Security as in FORM 01
<input type="checkbox"/>	<input type="checkbox"/>	2. Letter of Proposal as in FORM 02
<input type="checkbox"/>	<input type="checkbox"/>	3. Copy of Business Registration Certificate
<input type="checkbox"/>	<input type="checkbox"/>	4. Board Resolution as in SECTION IV 3.4
<input type="checkbox"/>	<input type="checkbox"/>	5. Proposal Checklist in FORM 05 attached outside sealed proposal.

NOTE:

- **PROPOSALS WITHOUT THE SPECIFIED DOCUMENTS STATED IN THE FORM 05 PROPOSAL CHECKLIST (EXCLUDING FORM 05 - PROPOSAL CHECKLIST) WILL BE REJECTED AT THE TIME OF PROPOSAL OPENING.**
- **ANY BANK STATEMENTS WILL NOT BE ACCEPTED WITH THE PROPOSAL. REQUIRED FINANCIAL DOCUMENTS MUST BE SUBMITTED AS PER CLAUSE 4 (FINANCIAL DOCUMENTS) OF SECTION V. BUSINESS PROPOSAL REQUIREMENT.**



FORM 06 - PROPONENTS CHECKLIST

Proponents shall confirm that all the required documents are submitted along with the proposals submitted. Proponents Checklist shall be checked and signed by the Proponent and shall be submitted along with the proposal.

1. Proposal Documents:	
	Price Proposal Form
	Bid Security
	Business Plan (if required)
	Experience (if required)
2. Legal Documents:	
Sole Proprietors:	
	Business Registration Certificate
	Information of the Authorized Representative as in Form 03
	Power of Attorney to sign on behalf of the Proponent
Companies:	
	Business Registration Certificate
	Information of the Authorized Representative as in Form 03.
	Power of Attorney to sign on behalf of the Proponent
	For Partnership: Partnership Deed / Agreement
	Memorandum and Articles of Association of the Company
	Board Resolution of the Company confirming Board of Director's approval for proposed work
	Document indicating the ownership and shareholding structure of the Proponent
3. Financial Documents:	
	HDC statement of the Due Clearance
	Method of Financing Form
4. Documents required based on the proposed Method of Financing:	
<u>If Equity Financing is proposed:</u>	
	Monthly Average Balance Confirmation of the most recent 12 (twelve) months or End Balance Confirmation of the business entity authorized and sealed (stamped) by bank/financial institution of the external financier
	For Companies, audited financial statements of most recent year (2021) authorized by a certified audit firm.
	Management Account of the year 2022
<u>If bank financing is proposed:</u>	
	Bank Comfort letter
<u>For equity injection:</u>	
	Commitment letter from shareholders
	Average Balance Confirmation of the past 12 months or End Balance Confirmation authorized and sealed (stamped) by bank/financial institution of the shareholders (OR) Audited Financial statements of the most recent year (2021) and management account of the year 2022 (OR) Relevant documents for bank financing by shareholder Relevant documents for external financing by shareholder



<u>For external financing:</u>	
	Commitment letter of the financier
	Average Balance Confirmation of the past 12 months or End Balance Confirmation authorized and sealed (stamped) by bank/financial institution of the external financier (OR) Audited Financial statements of the most recent year (2021) and management account of year 2022 (OR) Relevant documents for bank financing by financier

We hereby confirm that we have submitted the above-mentioned documents along with the proposal. We understand that the proposal will be disqualified if the documents are not in accordance with Section V. Business Proposal Requirement.

Proponent:

Name:

Address:

.....

Signature and Stamp



FORM 07 - DECLARATION OF IMMEDIATE FAMILY MEMBERS

Date:
Name of the Project:
Proposal Reference Number:
Proponent Name:
Name of the Authorized Signatory:

We, **[insert business name and business registry number]**, hereby confirm and declare that;

- 1. has a relation (Immediate family members employed at HDC) that puts in a position to influence the proposal of the proponent, or influence the decisions of the Lessor regarding the RFP process, (Yes/No)
- 2. If Yes, specify the details relating to the information pursuant to Clause 1 above are as follows;

NID No.	Family member / Relatives Name	Relationship	Position/Title

- 3. I hereby confirm the following;
 - a. That the information above is true, accurate and if all or any part of them are found to be untrue, HDC shall have the right to disqualify and reject the bid/proposal/quotation or terminate the agreement/work order,
 - b. I am also obliged to inform and disclose to HDC if there are any changes to the declaration herein, within ten (10) days from the occurrence of such changes.

Name:

Date:

Signature



SECTION VI. CONTRACT TERMS

1.	Parties to the Agreement	<p>Housing Development Corporation Ltd HDC Building Hulhumalé</p> <p>(hereinafter referred to as "Lessor", which expression shall include its successors-in-title, liquidators, administrators and lawful assignees where the context so requires or admits).</p> <p>[Address of the successful Proponent]</p> <p>(hereinafter referred to as "Lessee", which expression shall include its successors-in-title, liquidators, administrators and lawful assignees where the context so requires or admits)</p>						
2.	Objective	2.1 The objective of this Agreement is to lease the unit for the provision of Retail Store From STELCO (Hiyaa) Commercial.						
3.	Unit Detail	<table border="1" style="width: 100%; border-collapse: collapse;"> <thead> <tr> <th style="width: 50%; text-align: center;">Unit No:</th> <th style="width: 50%; text-align: center;">Unit Area (Sqft)</th> </tr> </thead> <tbody> <tr> <td style="text-align: center;">20458-G-02</td> <td style="text-align: center;">595.03</td> </tr> <tr> <td style="text-align: center;">20458-G-03</td> <td style="text-align: center;">595.03</td> </tr> </tbody> </table>	Unit No:	Unit Area (Sqft)	20458-G-02	595.03	20458-G-03	595.03
Unit No:	Unit Area (Sqft)							
20458-G-02	595.03							
20458-G-03	595.03							
4.	Unit Usage	4.1 The unit should only be used to retail store.						
5.	Lease Term	5.1 The lease period is 05 (five) years from the date of handover of premises.						
6.	Business Model & Lease Rate	<p>6.1 The Business Model is Lease model, whereby the Lessee agrees to pay the proposed lease to the Lessor.</p> <p>6.2 The lease rate per square feet per month for Year 1 is MVR 40.00 (Maldivian Rufiyaa Forty).</p> <p>6.3 The lease rate per square feet per month for Year 2 to Year 5 will be proposed lease rate of the successful Proponent.</p> <p>6.4 The lease rate will be effective from the date of unit handover.</p>						
7.	Conditions Precedent	<p>7.1 Agreement will only be signed upon fulfilment of the following conditions precedent:</p> <ul style="list-style-type: none"> • Payment of Lease Deposit as per Clause 8. • Submission of Concept Design and Work Schedule and obtaining approval of Concept Drawing by Lessor as per Clause 9. 						
8.	Lease Deposit	<p>8.1 The lease deposit amount shall be 03 (three) months' lease of the lease rate for Year 1.</p> <p>8.2 This amount should be paid within 07 (seven) working days from the date of conditional award.</p>						

		<p>8.3 Lease Deposit will be paid back within 01 (one) Month upon expiration of the Agreement after adjusting for any unpaid lease, penalty or expenses that Lessor may incur linked to the Agreement and the unit, such as but not limited to unpaid utility bills.</p> <p>8.4 If the Agreement is terminated by the Lessee before the expiration of the Agreement term without the notice period specified under clause 15.7, the Lessor has the right to take the security deposit amount in full.</p>
9.	Concept Drawing	<p>9.1 The Concept Drawings must comply with the Unit Design Guideline provided by HDC.</p> <p>9.2 The Concept drawings must be submitted within 20 (twenty) Calendar Days from the receipt of the Conditional Award Letter Date.</p> <p>9.3 The Lessor must inform in writing to the Lessee of the approval of the concept drawing or comments to the concept drawings if any within 14 (fourteen) working days of Submission Date.</p> <p>9.4 If corrections need to be made to the submitted concept drawing, Lessee shall ensure rectifications and submission of the revised concept drawings as per the comments of HDC within 14 (fourteen) calendar days of HDC's comments being communicated, failing to do so will result in annulment of the Conditional Award Letter.</p> <p>9.5 The developer shall address all the issues highlighted in comments provided by HDC for drawings prior to the submission of revised concept.</p> <p>9.6 Revisions to concept drawing cannot be submitted prior to receiving comments from HDC.</p> <p>9.7 Corrections can be made to the concept only up to a maximum of two times.</p> <p>9.8 If the concept is changed / revised and resubmitted for approval, after the initial approval has been given, the Lessee will be charged a reviewing fee of MVR 3.00 (Maldivian Rufiyaa Three) per square meter.</p>
10.	Grace Period	<p>10.1 The first 03 (three) months from the date of Unit handover, shall be a grace period where no rent shall be payable by the Lessee.</p> <p>10.2 Additional 1 month of rent free to be granted to the parties who manage to complete and open the unit within the grace period.</p>
11.	Unit Handover	<p>11.1 The Unit will be handed over to the Lessee within 07 (seven) working days after signing the Agreement.</p>

12.	Option to Renew Term	<p>12.1 The Lessor may at its discretion give the Lessee option to renew or extend the Term, provided that the Lessee requests to renew or extend the Term at least 06 (Six) months prior to expiration of the Term. However, such renewal or extension may be granted based on the Lessee's performance under the Agreement. The Lessor and the Lessee shall negotiate the new extension of the Term. In the event that the Lessor and the Lessee fail to reach mutual Agreement with regard to the terms and conditions for renewal or extension of the Term latest by 03 (Three) months prior to expiration of the Term, then the Agreement shall expire at the end of the Term.</p>
13.	Duties and Obligation of Lessee	<p>13.1 Utilize the leased Premises only for the specific usage detailed in Clause 4, and remain consistent in carrying out the work.</p> <p>13.2 The Lessee shall ensure to commence the operation no later than one month from the end of grace period.</p> <p>13.3 The Lessee shall not store any flammable liquids, corrosive materials and/or gas cylinders at the leased space.</p> <p>13.4 The Lessee shall not store any unlawful material or substances (whether in direct or indirect contravention of the laws of the Republic of Maldives) on the Property and shall adhere to the rules and regulations enforced by the Government Authorities.</p> <p>13.5 The Lessee shall not, either intentionally or unintentionally cause any damage to the property or any other neighboring property or violate any rules and regulations pertained by HDC. Such damage includes, but is not limited, to dumping garbage, pollution, unlawful entry, and waste disposal.</p> <p>13.6 The loading and unloading processes shall not cause any disturbances or congestions to any third party.</p> <p>13.7 The Lessee shall not be allowed to make any alteration, changes, replacements, improvements or additions (any of which is an alteration) in and to the premises at any time, unless approved by HDC.</p> <p>13.8 Use the Premises to provide facilities or services that conform to the rules and regulations and Lessor's guidelines which may be issued and/or modified from time to time, and the rules and regulations enforced by the relevant Authority or any other institution in charge of issuing of permits or authorizations.</p> <p>13.9 Make payments to the relevant Authorities for all utility services consumed or supplied inclusive of electricity meters, water meters and telecommunication connections to the Premises during the Term. The Lessor and the Lessee confirm the</p>

Handwritten signature

		<p>readings for the electricity and water supply meters on the Premises at the time of occupation of the Premises.</p> <p>13.10 Not to assign, sublet, charge or part with or share possession or otherwise dispose of the Premises or any of its rights, obligations, or responsibilities under the Agreement without the prior written consent of the Lessor.</p>
14.	Duties and Obligation of Lessor	<p>14.1 The Lessor must handover the unit as per the clause 11.1.</p> <p>14.2 The Lessor Must provide comments to the drawings within 14 (fourteen) days of submission of the drawings</p> <p>14.3 The Lessor should provide all the required information requested by the Developer, without unreasonably withholding or delaying the information. HDC shall not be held responsible for any delay caused which is beyond the control of HDC. Nevertheless, where possible, HDC shall make the best of efforts to minimize the delay.</p>
15.	Termination	<p>15.1 Lessor may serve 30 (thirty) calendar days written notice to the Lessee to terminate the Agreement in the event the Lessee fails to pay the rent and/or penalty as per the terms of the Agreement for a period of 03 (three) consecutive months.</p> <p>15.2 The Lessor may terminate the Agreement without any compensation payable to the Lessee in the event the rent due and/or penalty remains unpaid at the end of 30 (thirty) calendar days written notice period.</p> <p>15.3 If the Lessee fails to perform any of its obligation under the Agreement, the Lessee shall be granted a period to rectify the breach along with a fine amount between MVR 5,000 (Maldivian Rufiyaa Five Thousand) and MVR 100,000 (Maldivian Rufiyaa One Hundred Thousand) considering the degree of the breach, to be determined by the sole discretion of the Lessor.</p> <p>15.4 If the Lessee fails to pay the fine and cure the breach within the extension period, the Lessor has the right to terminate the agreement and give the Lessee a duration of not less than 30 (thirty) calendar days to vacate the unit and handover the unit to the Lessor</p> <p>15.5 The Lessor may terminate the agreement immediately without any prior written notice, if the Lessee fails to perform any of the fundamental obligations</p> <p>15.6 The Lessor may terminate the Agreement by serving 06 (six) months' written notice upon the Lessee of its intention to do so for any reason whatsoever.</p>

Handwritten signature

SECTION VII. DRAWINGS AND GUIDELINES

1. DRAWINGS

The drawing contains the location map and unit map of the unit to be allocated for the development.

* Areas in the drawings is subjected to minimal changes.

(Refer to next page)



A handwritten signature in blue ink, appearing to be 'J. J.', located below the logo.



PHASE 2

PHASE 1

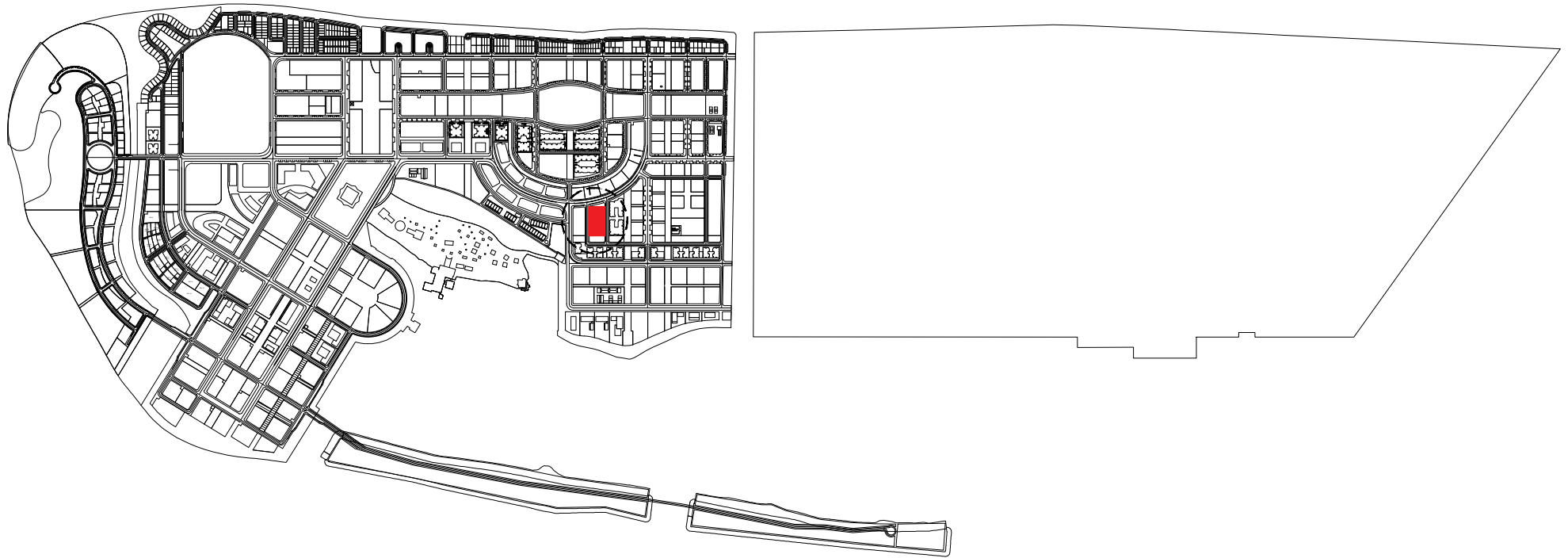

PROPERTY : 20458 COMMERCIAL (HIYAA STELCO)
LOT NO.: 20458,

N.T.S

PROPERTY : 20458 COMMERCIAL (HIYAA STELCO)

Scale : AS GIVEN Drawn by: Fathina Checked by: Fathina Date: 17th OCTOBER 2022 Remarks:

LOCATION MAP

**HOUSING
DEVELOPMENT
CORPORATION**
REAL ESTATE MANAGEMENT
3RD FLOOR, HDC BUILDING HULHUMALE'
REPUBLIC OF MALDIVES
TEL. +9603353535, FAX +9603358892
EMAIL : mail@hdc.com.mv

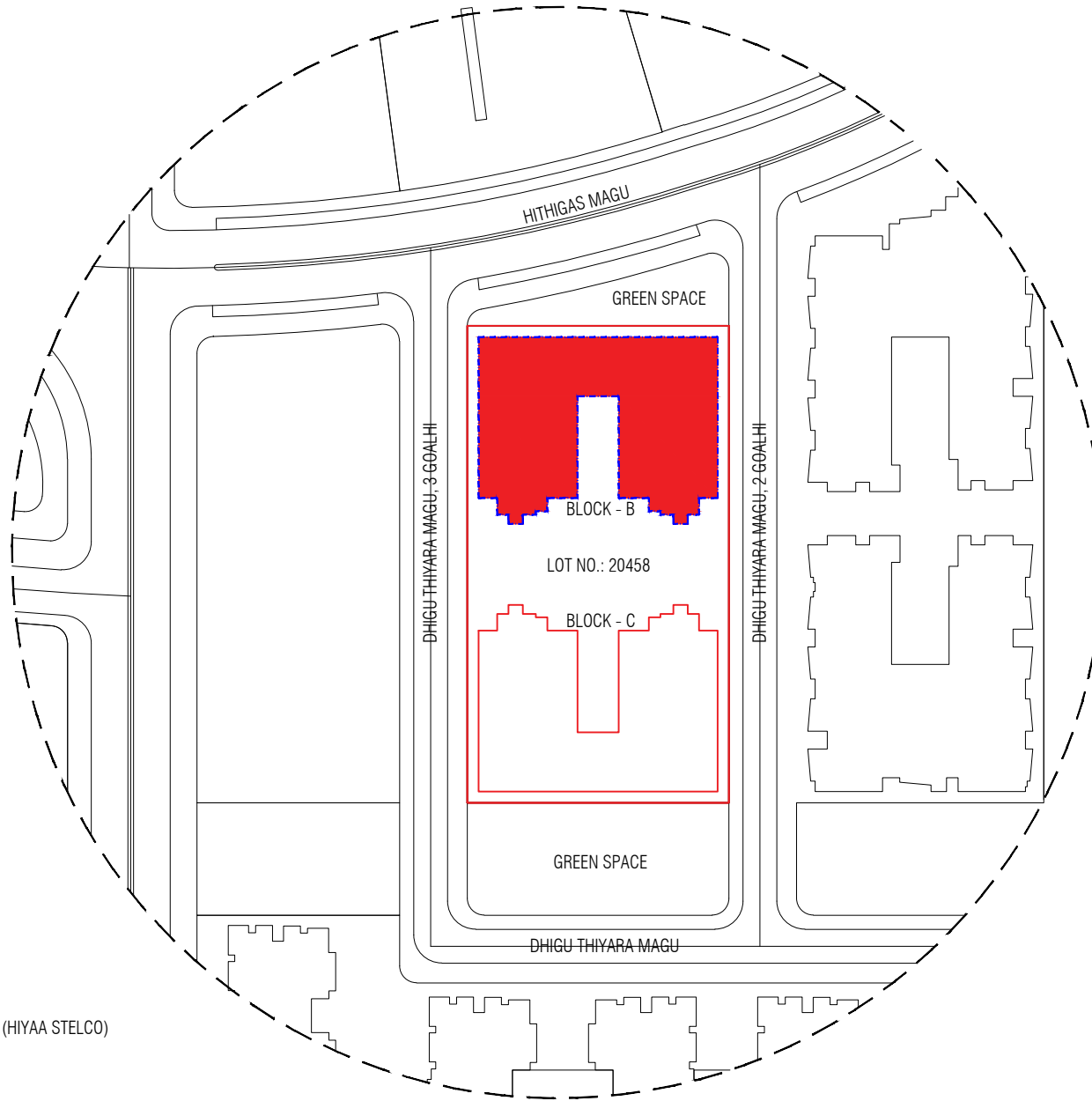

PROPERTY : 20458 COMMERCIAL (HIYAA STELCO)
 LOT NO.: 20458,

N.T.S

PROPERTY : 20458 COMMERCIAL (HIYAA STELCO)

Scale : AS GIVEN Drawn by: Fathina Checked by: Fathina Date: 17th OCTOBER 2022 Remarks:

SITE PLAN



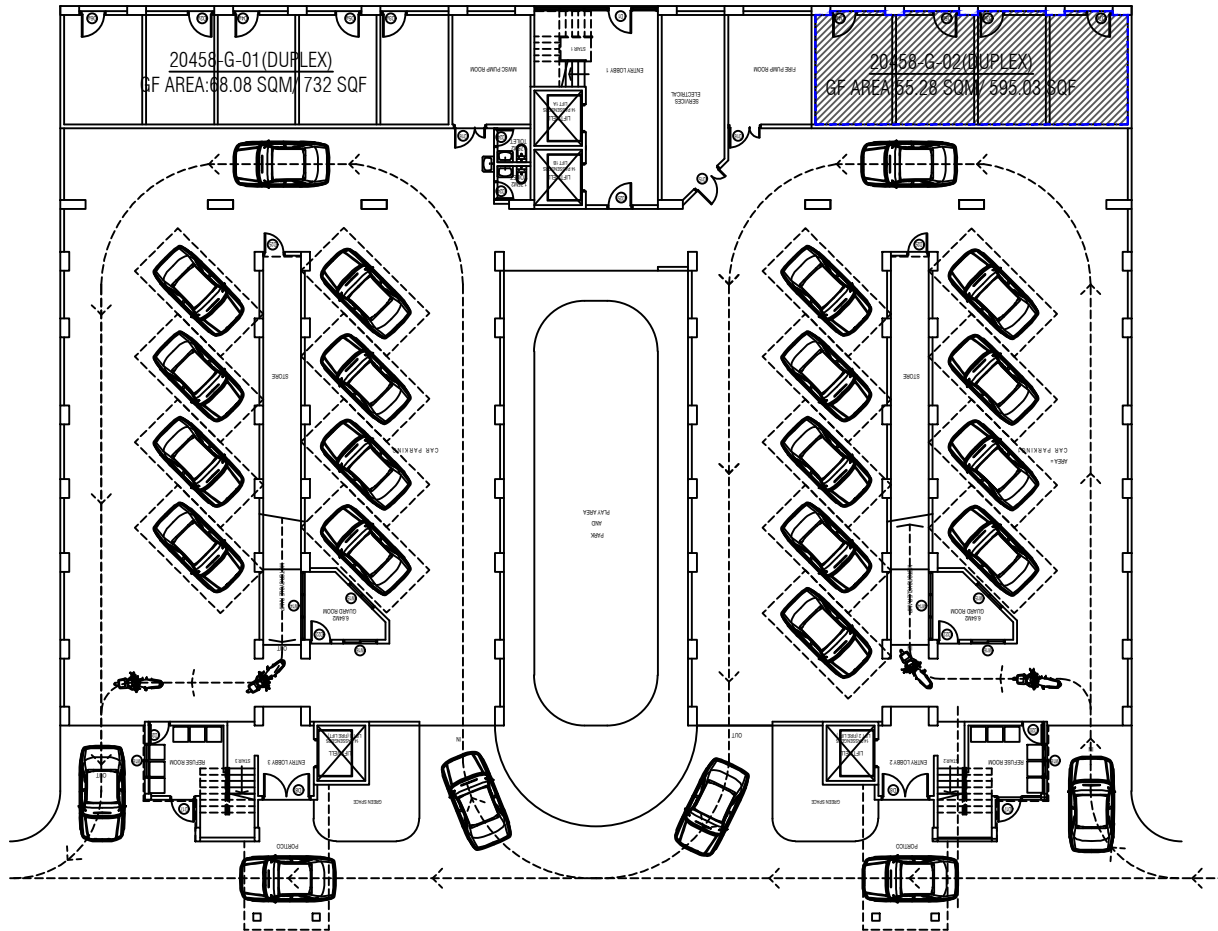

PROPERTY : 20458 COMMERCIAL (HIYAA STELCO)
LOT NO.: 20458, HITHIGAS MAGU

20458-G-02(DUPLICATE)
GF AREA:55.28 SQM/ 595.03 SQF
1FL AREA: OPEN FLOORING

TOTAL FLOOR AREA: 60.08 SQM/ 732 SQF

1:300

PROPERTY : 20458 COMMERCIAL (HIYAA STELCO)

GROUND FLOOR PLAN

Scale : AS GIVEN

Drawn by: Fathina

Checked by: Fathina

Date: 17th OCTOBER 2022

Remarks:



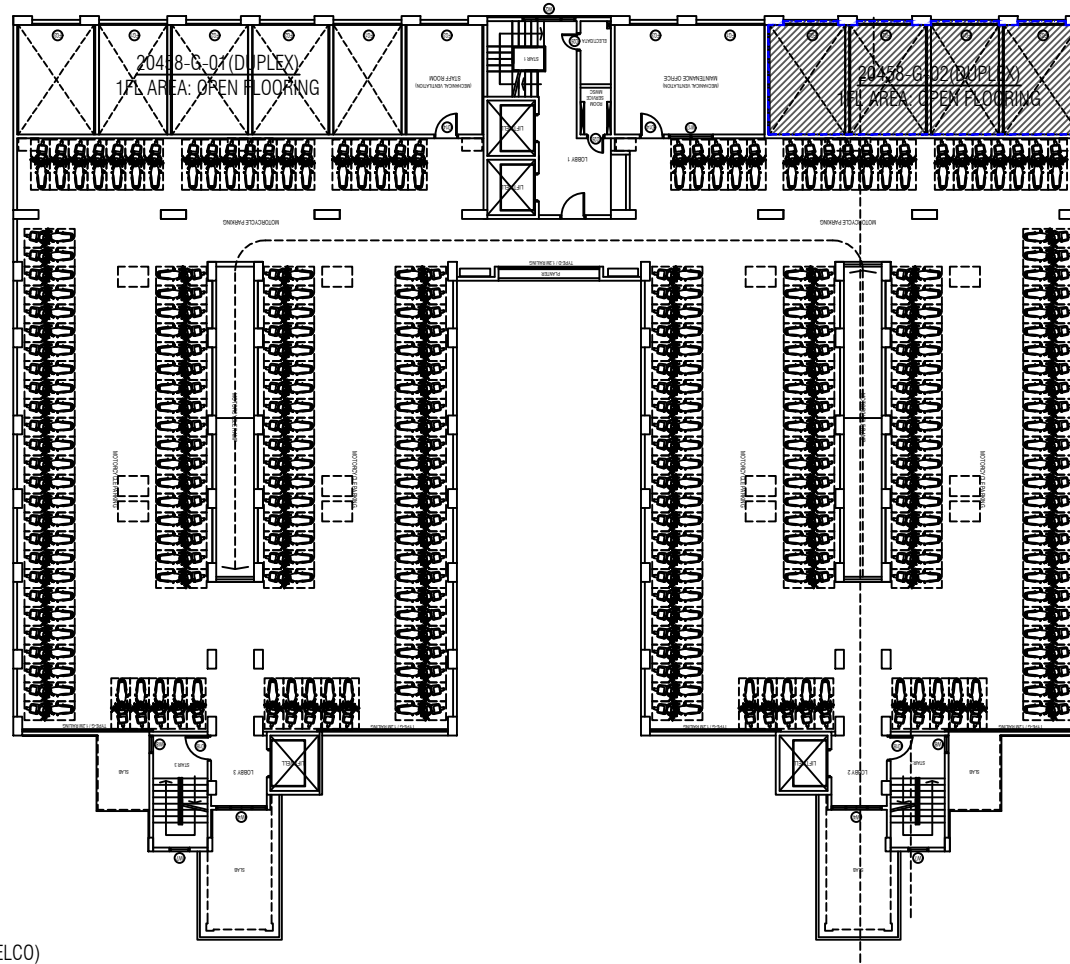

PROPERTY : 20458 COMMERCIAL (HIYAA STELCO)
 LOT NO.: 20458, HITHIGAS MAGU

20458-G-02(DUPLICATE)
 GF AREA:55.28 SQM/ 595.03 SQF
 1FL AREA: OPEN FLOORING

TOTAL FLOOR AREA: 55.28 SQM/ 595.03 SQF

1:300

PROPERTY : 20458 COMMERCIAL (HIYAA STELCO)

Scale : AS GIVEN

Drawn by: Fathina

Checked by: Fathina

Date: 17th OCTOBER 2022

Remarks:

FIRST FLOOR PLAN



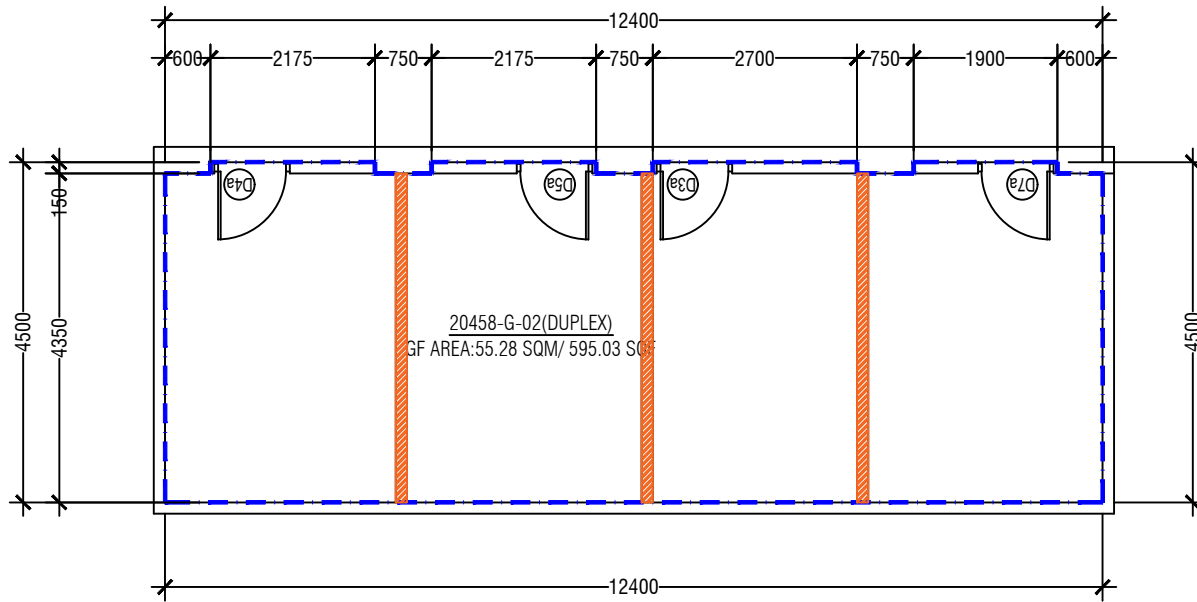



PROPERTY : 20458 COMMERCIAL (HIYAA STELCO)
LOT NO.: 20458, HITHIGAS MAGU

20458-G-02(DUPLEX)
GF AREA: 55.28 SQM/ 595.03 SQF
1FL AREA: OPEN FLOORING

TOTAL FLOOR AREA: 55.28 SQM/ 595.03 SQF

1:300

NOTE:

-  TOTAL UNIT BOUNDARY LINE
-  EXISTING BLOCK WALLS IN THE UNIT

PROPERTY : 20458 COMMERCIAL (HIYAA STELCO)

Scale : AS GIVEN

Drawn by: Fathina

Checked by: Fathina

Date: 17th OCTOBER 2022

Remarks:

GROUND FLOOR PLAN



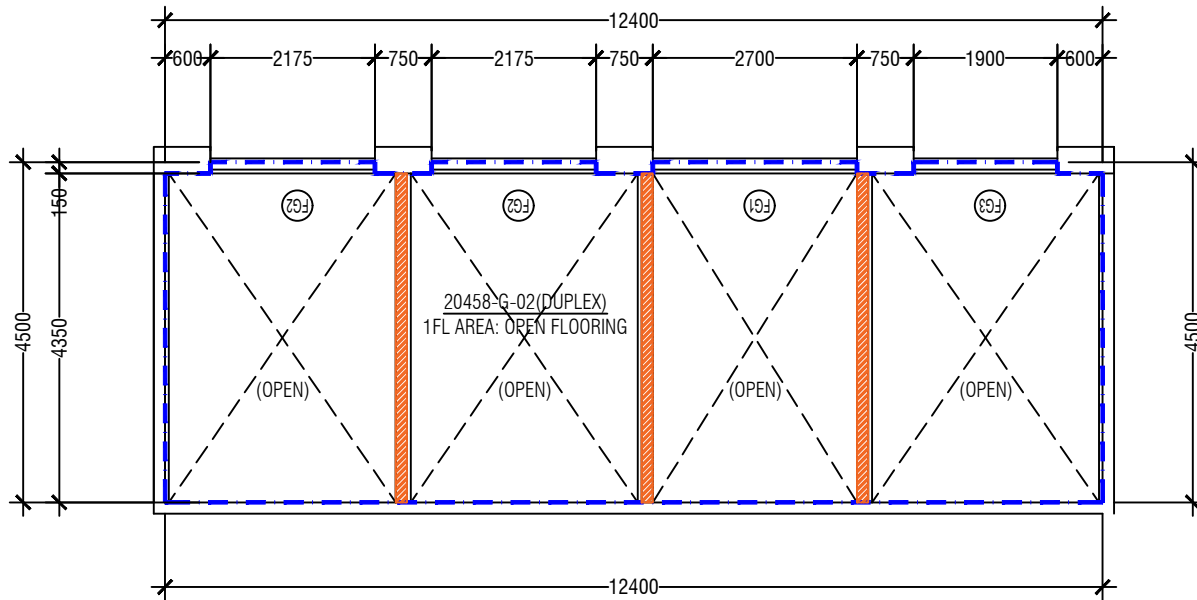



PROPERTY : 20458 COMMERCIAL (HIYAA STELCO)
LOT NO.: 20458, HITHIGAS MAGU

20458-G-02(DUPLEX)
GF AREA:55.28 SQM/ 595.03 SQF
1FL AREA: OPEN FLOORING

TOTAL FLOOR AREA: 55.28 SQM/ 595.03 SQF

1:300

NOTE:

-  TOTAL UNIT BOUNDARY LINE
-  EXISTING BLOCK WALLS IN THE UNIT

PROPERTY : 20458 COMMERCIAL (HIYAA STELCO)

Scale : AS GIVEN

Drawn by: Fathina

Checked by:Fathina

Date:17th OCTOBER 2022

Remarks:

FIRST FLOOR PLAN





PHASE 2

PHASE 1

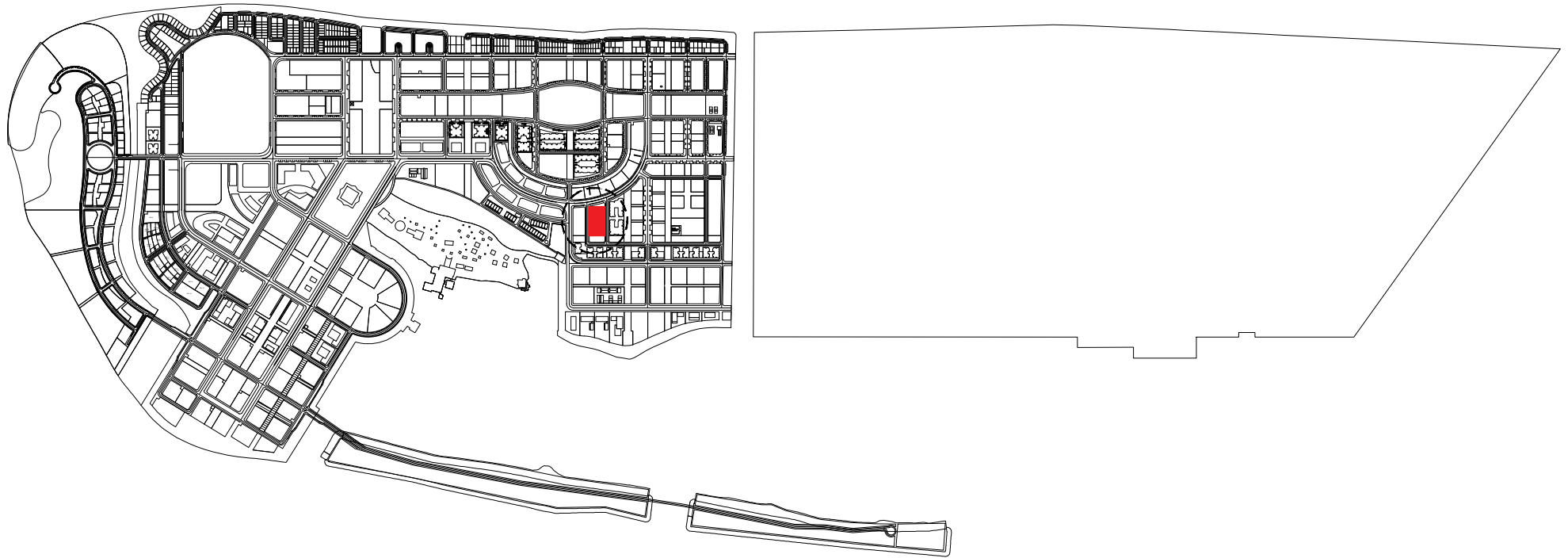

PROPERTY : 20458 COMMERCIAL (HIYAA STELCO)
LOT NO.: 20458,

N.T.S

PROPERTY : 20458 COMMERCIAL (HIYAA STELCO)

Scale : AS GIVEN Drawn by: Fathina Checked by: Fathina Date: 17th OCTOBER 2022 Remarks:

LOCATION MAP

HOUSING DEVELOPMENT CORPORATION
REAL ESTATE MANAGEMENT
3RD FLOOR, HDC BUILDING HULHUMALE'
REPUBLIC OF MALDIVES
TEL. +9603353535, FAX +9603358892
EMAIL : mail@hdc.com.mv



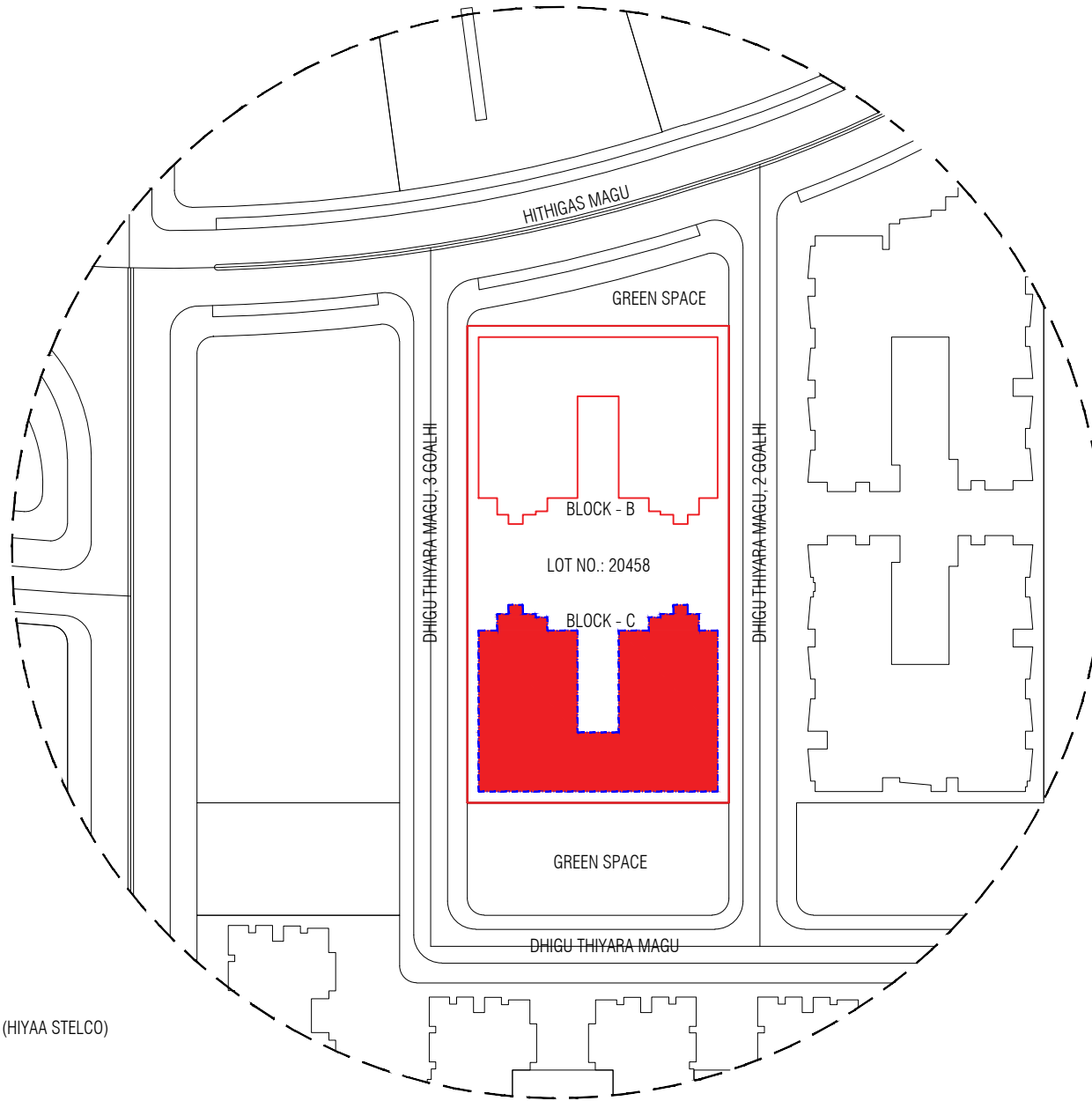

PROPERTY : 20458 COMMERCIAL (HIYAA STELCO)
 LOT NO.: 20458,

N.T.S

PROPERTY : 20458 COMMERCIAL (HIYAA STELCO)

Scale : AS GIVEN Drawn by: Fathina Checked by: Fathina Date: 17th OCTOBER 2022 Remarks:

SITE PLAN

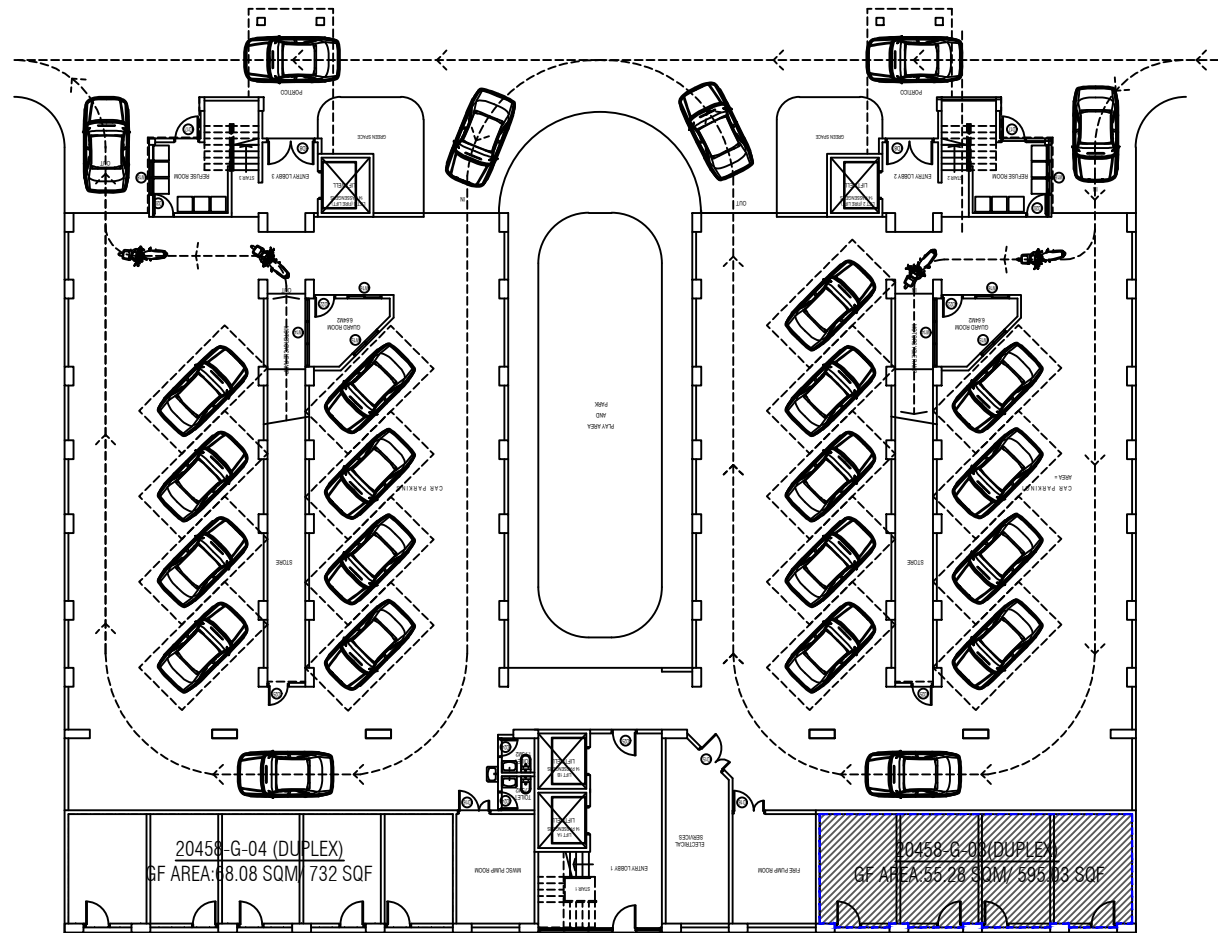

PROPERTY : 20458 COMMERCIAL (HIYAA STELCO)
 LOT NO.: 20458, DHIGUTHIYARA MAGU

20458-G-03(DUPLEX)
 GF AREA:55.28 SQM/ 595.03 SQF
 1FL AREA: OPEN FLOORING

TOTAL FLOOR AREA: 55.28 SQM/ 595.03 SQF

1:300

PROPERTY : 20458 COMMERCIAL (HIYAA STELCO)

GROUND FLOOR PLAN

Scale : AS GIVEN Drawn by: Fathina Checked by:Fathina Date:17th OCTOBER 2022 Remarks:

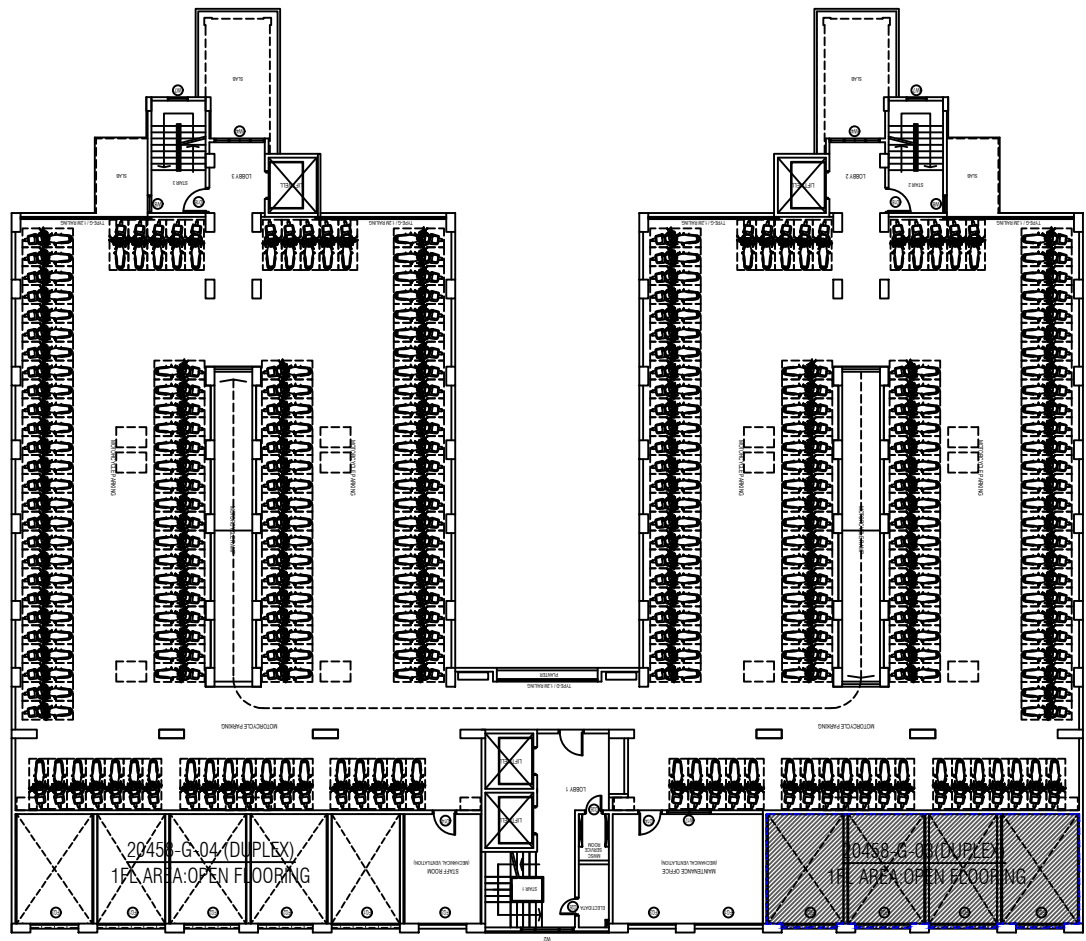

PROPERTY : 20458 COMMERCIAL (HIYAA STELCO)
 LOT NO.: 20458, DHIGUTHIYARA MAGU

20458-G-03(DUPLEX)
 GF AREA: 55.28 SQM/ 595.03 SQF
 1FL AREA: OPEN FLOORING

TOTAL FLOOR AREA: 55.28 SQM/ 595.03 SQF

1:300

PROPERTY : 20458 COMMERCIAL (HIYAA STELCO)

Scale : AS GIVEN

Drawn by: Fathina

Checked by: Fathina

Date: 17th OCTOBER 2022

Remarks:

FIRST FLOOR PLAN



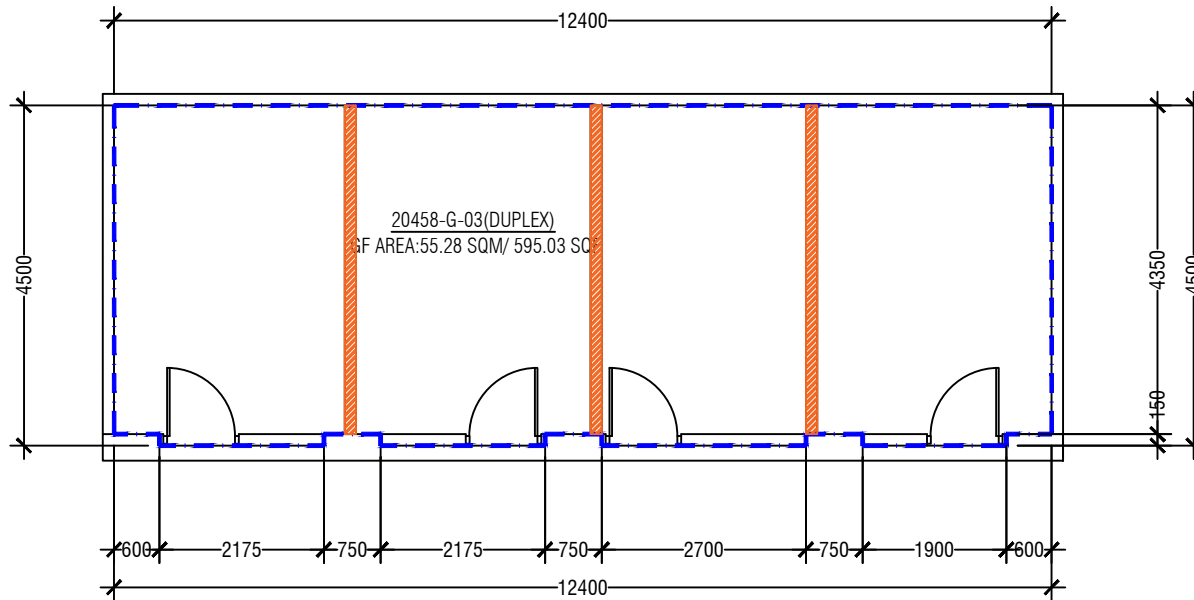



PROPERTY : 20458 COMMERCIAL (HIYAA STELCO)
LOT NO.: 20458, DHIGUTHIYARA MAGU

20458-G-03(DUPLEX)
GF AREA:55.28 SQM/ 595.03 SQM
1FL AREA: OPEN FLOORING

TOTAL FLOOR AREA: 55.28 SQM/ 595.03 SQM

1:300

NOTE:

-  TOTAL UNIT BOUNDARY LINE
-  EXISTING BLOCK WALLS IN THE UNIT

PROPERTY : 20458 COMMERCIAL (HIYAA STELCO)

Scale : AS GIVEN

Drawn by: Fathina

Checked by: Fathina

Date: 17th OCTOBER 2022

Remarks:

GROUND FLOOR UNIT LAYOUT

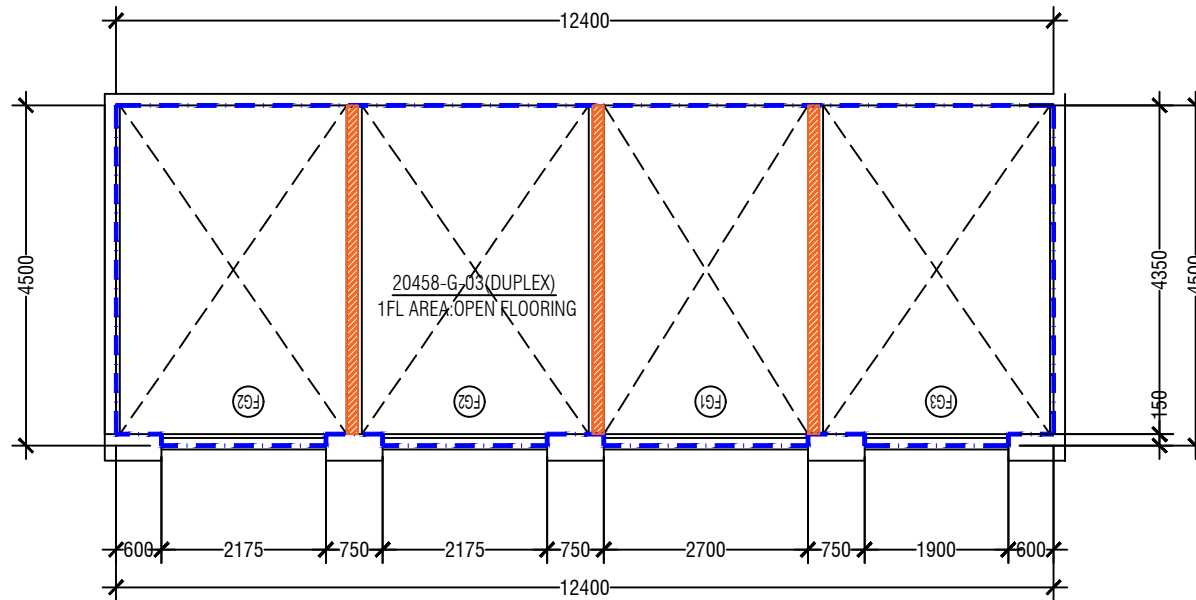



PROPERTY : 20458 COMMERCIAL (HIYAA STELCO)
LOT NO.: 20458, DHIGUTHIYARA MAGU

20458-G-03(DUPLEX)
GF AREA:55.28 SQM/ 595.03 SQF
1FL AREA: OPEN FLOORING

TOTAL FLOOR AREA: 55.28 SQM/ 595.03 SQF

1:300

NOTE:

-  TOTAL UNIT BOUNDARY LINE
-  EXISTING BLOCK WALLS IN THE UNIT

PROPERTY : 20458 COMMERCIAL (HIYAA STELCO)

FIRST FLOOR UNIT LAYOUT

Scale : AS GIVEN

Drawn by: Fathina

Checked by: Fathina

Date: 17th OCTOBER 2022

Remarks:

2. UNIT DESIGN GUIDELINES

(Refer to Next Page)



UNIT DESIGN GUIDELINE

COMMERCIAL UNITS IN HIYAA STELCO

(Lot 20458)

Version 1
Date: 19th October 2022

1. INTRODUCTION

This document is intended to communicate the standards and guidelines to be followed by the tenant occupying the commercial unit in Lot 20458 (Development: Hiyaa STELCO).

2. GENERAL

- Frontage refers to the front side, where the main entrance of the unit is located.
- Drawings refer to the design communication document that should be submitted to HDC for unit design approval.
- Tenant is advised to check the given dimensions on site if required.
- All the physical development works can be carried on site, after the unit design approval.
- If there are any design changes after the initial design approval, tenant should submit revised drawings or as-built drawings for revision approval prior to applying for 'Building usage for commercial use'.

3. DESIGN GUIDELINE

FRONTAGE DESIGN

- Tenants can propose to re-design and build new façade for the unit.
- Predominant material of the proposed façade should be glass in order to establish urban connection and liveliness between commercial usage and urban surrounding.
- The clear glass façade can be finished with stickers/ frosted sticker according to the usage and branding.

INSTALLATION OF A DECK AT FIRST FLOOR LEVEL

- Tenants can propose to install a deck at first floor level.
- Deck can be built by metal or timber framed structure.
- Proposed structural design submitted should be checked and stamped by a structural checker.

UTILITIES & SERVICES

- AC outdoor unit can only be installed at an approved location by HDC. AC drain pipes should not be left without exiting to a floor drain pipe or a soak pit.
- A dome type security camera is allowed to be placed on the façade of the given unit if required.
- Waste management area must be given in the unit with multiple bin space for waste segregation. (Should be show on floor plan)
- Proposed kitchen hood and exhaust system must be a product with odour control and grease trap incorporated. (Location must be shown on floor plans).
- Kitchen exhaust exit should not face directly to the pedestrian passing nearby.

STANDARD DIMENSIONS

- Minimum height of an entrance door should be 2.1m.
- Universal access to the unit should be provided. (1:12 slope or 1:10 slope as minimum)

SIGNAGE / ADVERTISEMENT BOARDS

- Business name board can be installed on the allocated locations for business name boards, length is limited to length of the given unit.
- Each business is allowed to install 1 business logo or name board of 600x600mm, projected from the given unit façade to the corridor at a height of 2.2m from finished ground floor level. No projection is allowed between corridor finished floor level and 2.2m from ground floor finished level.
- Advertisement boards are allowed on the façade with given dimension in guideline drawings. Advertisement board must be framed in 25mm metal framing and finished with clear material as a covering. Submit detail design for approval if otherwise.

REQUIRED SPECIFICATIONS

- Any mechanical equipment (such as dumbwaiters, kitchen hood and exhaust) proposed to install on the building structure; a product specification must be submitted to HDC for review and approval.

OTHER

- The tenant should be responsible for any damages occurred to the property and/or its users in installing / modifying any component of the unit.

4. DRAWING REQUIREMENTS

Unit design drawings should be submitted to HDC for design approval with the following requirements:

STAGE-1

1. A Title Block with following information must be given on each page.
 - a. Tenant name, commercial unit number and given usage (eg: shop, clinic, service center etc)
 - b. Drawing title, scale, revision no. and date
2. As-built plan
3. Demolition plan (if there are any demolitions proposed)
4. Proposed floor plans (space labels, floor finished levels, furniture layout and dimensions should be given)
5. Exterior & interior elevations (preferably with finished materials)
6. Minimum 1 section through the unit with floor finished levels.
7. Door and window schedule (Specify materials, colour, dimensions)
8. Material / Product specifications.
9. Structural drawings, if any such modifications are proposed (should be signed by a Certified Structural Engineer).
10. Schematic services drawings.
 - Proposed plumbing layouts



- Ventilation layout
- Electrical layout and electrical load calculation (if required)
- Electrical load calculations submitted should be, signed by a registered professional from the relevant authorities.

STAGE-2

Following drawings can be submitted after agreement signing and prior to applying for 'Building usage for commercial use' permit.

11. Detail services drawings fit to guidelines set by relevant authorities and approved by them (if approval is required by the relevant authorities).
 - a. Electrical and Power layout
 - b. Lighting layout
 - c. Plumbing layout (Fresh water, grey water & WC pipe layout)
 - d. Ventilation layout (AC outdoor unit location and drain pipe should be shown)
 - e. CCTV layout
 - f. Any other building services layout incorporated within the unit.
12. MNDF Approved firefighting layout, site checked and approved letter by MNDF.

5. DISCLAIMER



HDC reserves the right to evaluate and impose conditions not covered in these guidelines in response to specific design or usage depending on merits. HDC reserves the right to modify or withdraw any part of this guideline and to make such other and further changes as deemed necessary for the operation of the commercial area and these guidelines will be binding upon each tenant.





ELEVATION (COMMERCIAL FRONTAGE)
1:200

LEGEND

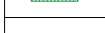
	UNIT FRONTAGE
	BUSINESS NAME BOARD
	ADVERTISEMENT SPACE
	BUSINESS LOGO 600 X 600 MM PROJECTED FROM FACADE